

RUTLAND GUTTER SUPPLY LLC

rutlandguttersupply@yahoo.com Ph: 407-859-1119 Fax: 407-859-1123

CU001S 6 SIDED

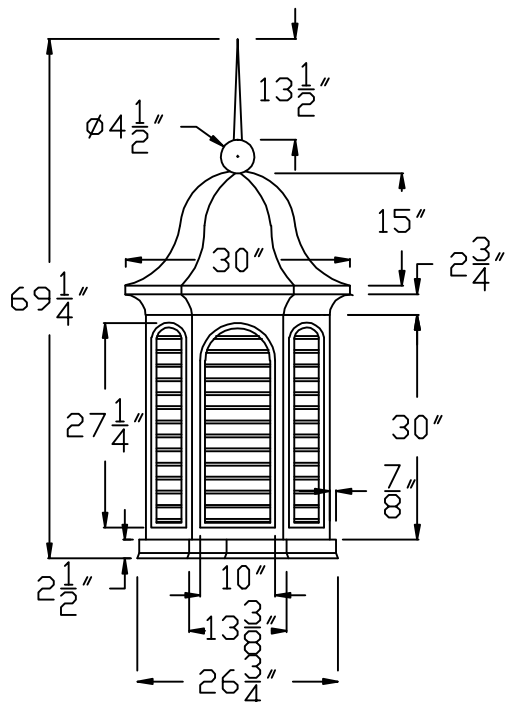

FRONT VIEW

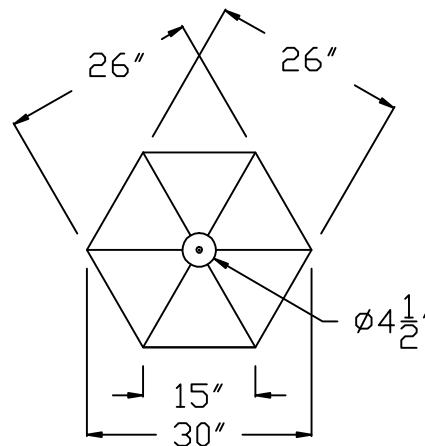



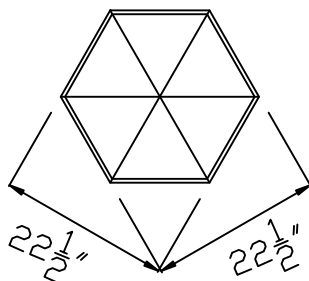







TOP VIEW



BASE SIZE

Scale: NONE

SELECT ROOF SHAPE

- | | | | | | |
|---|--|---|---|---|---|
|  |  |  |  |  | |
| Flat Roof | Gable | Hip Pyramid | Hip-Ridge | Hip End & Ridge | |
|  |  |  |  |  |  |
| 5-Facet Hip | 6-Facet Hip | 7-Facet Hip | Hexagon Turret | Octagon Turret | Cone Turret |

Company:	Item: CU001S 6 SIDED
Invoice:	Material:
PO#:	Notes:
Architect:	
Contractor:	
Date:	
Approved by:	
Signature:	

CUSTOM ORDERS CAN NOT BE RETURNED