

# RUTLAND GUTTER SUPPLY LLC

sales@rutlandguttersupply.com Ph: 407-859-1119 Fax: 407-859-1123

## FL007

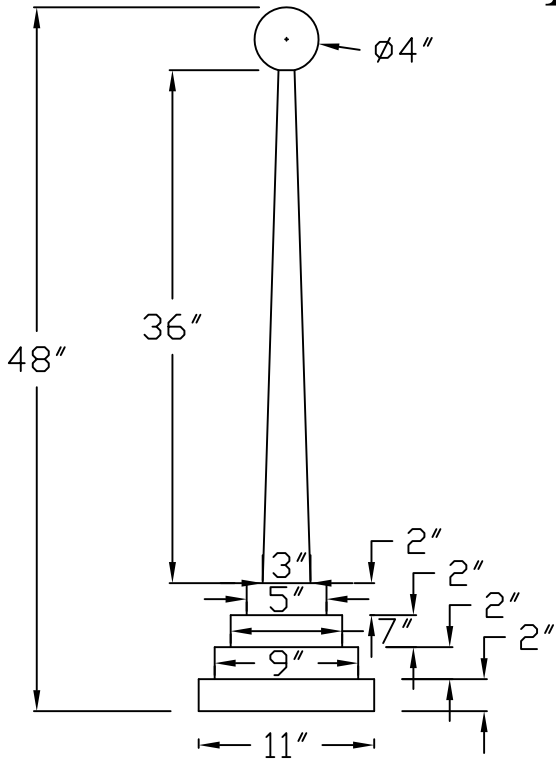

**FRONT VIEW**

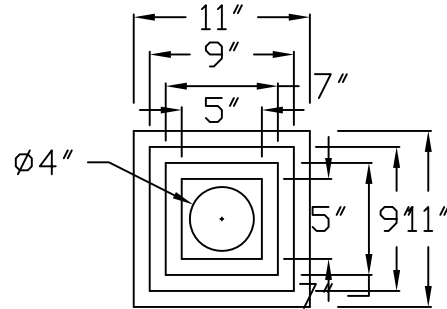

**TOP VIEW**







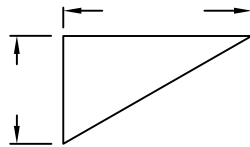
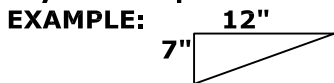



**SPECIFY ROOF PITCH**

To determine roof pitch:  
Use a straight edge atleast 12" long,  
Put corner on roof, holding vertically  
level.

At the 12" point, measure down. This  
is your roof pitch.



**SELECT ROOF SHAPE**

-  Flat Roof
-  Gable
-  Hip Pyramid
-  Hip End & Ridge
-  Cone Turret
-  5-Facet Hip
-  6-Facet Hip
-  7-Facet Hip
-  Hexagon Turret
-  Octagon Turret

<b>Company:</b>	<b>Item:</b> FL007
<b>Invoice:</b>	<b>Material:</b>
<b>PO#:</b>	<b>Notes:</b>
<b>Architect:</b>	
<b>Contractor:</b>	
<b>Date:</b>	
<b>Approved by:</b>	
<b>Signature:</b>	

**CUSTOM ORDERS CAN NOT BE RETURNED**