

RUTLAND GUTTER SUPPLY LLC

sales@rutlandguttersupply.com Ph: 407-859-1119 Fax: 407-859-1123

FL010

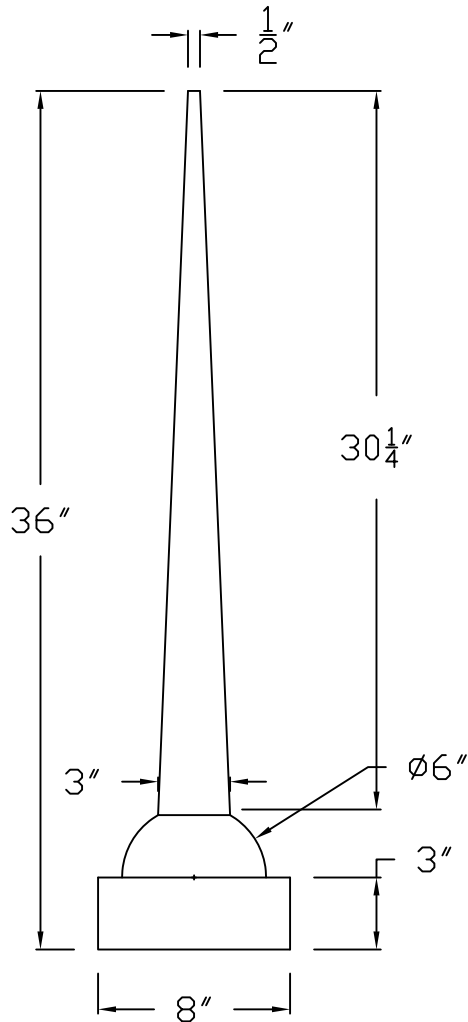



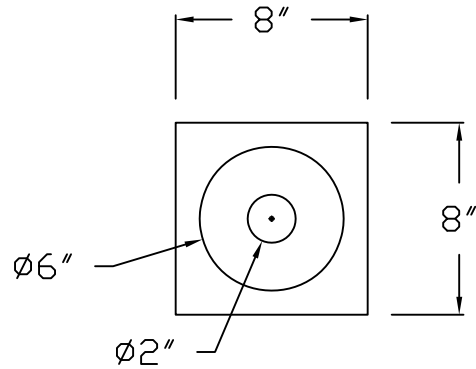







FRONT VIEW



TOP VIEW

SELECT ROOF SHAPE

-  Flat Roof
-  Gable
-  Hip Pyramid
-  Hip End & Ridge
-  Cone Turret
-  5-Facet Hip
-  6-Facet Hip
-  7-Facet Hip
-  Hexagon Turret
-  Octagon Turret

ROOF PITCH

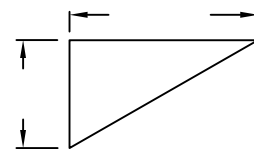

To determine roof pitch:
Use a straight edge at least 12" long,
Put corner on roof, holding vertically level.

At the 12" point, measure down. This is your roof pitch.

EXAMPLE: 12"

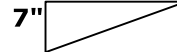

Company:	Item: FL010
Invoice:	Material:
PO#:	Notes:
Architect:	
Contractor:	
Date:	
Approved by:	
Signature:	

CUSTOM ORDERS CAN NOT BE RETURNED