

# RUTLAND GUTTER SUPPLY LLC

rutlandguttersupply@yahoo.com Ph: 407-859-1119 Fax: 407-859-1123

## LH016

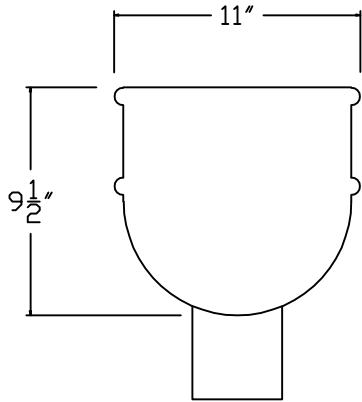

BACK VIEW

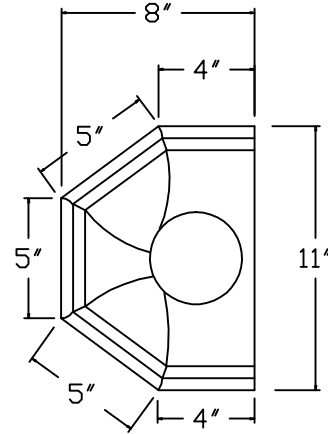

TOP VIEW

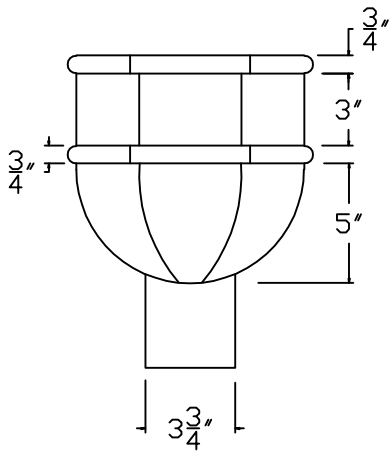

FRONT VIEW

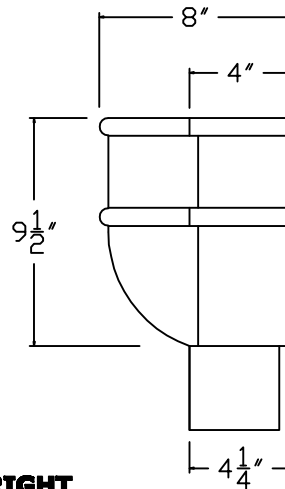

SIDE VIEW

**RUTLAND RESERVES THE RIGHT TO CHANGE OR MODIFY. DIMENSIONS SHOWN ARE FOR REFERENCE ONLY**

|                     |                  |
|---------------------|------------------|
| <b>Company:</b>     | <b>Item:</b>     |
| <b>Invoice:</b>     | <b>Material:</b> |
| <b>PO#:</b>         | <b>Notes:</b>    |
| <b>Architect:</b>   |                  |
| <b>Contractor:</b>  |                  |
| <b>Date:</b>        |                  |
| <b>Approved by:</b> |                  |
| <b>Signature:</b>   |                  |

**CUSTOM ORDERS CAN NOT BE RETURNED**