

RUTLAND GUTTER SUPPLY LLC

sales@rutlandguttersupply.com Ph: 407-859-1119 Fax: 407-859-1123

FL005

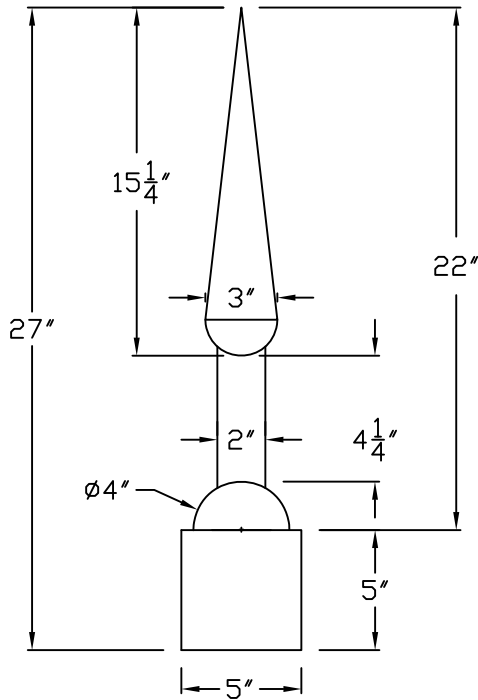

FRONT VIEW

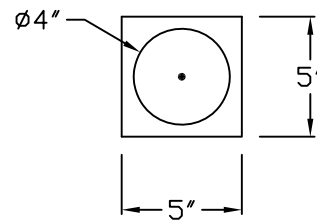

PLAN VIEW







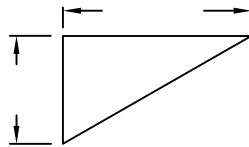
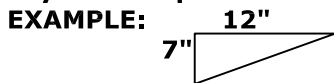



SPECIFY ROOF PITCH

To determine roof pitch:
Use a straight edge atleast 12" long,
Put corner on roof, holding vertically
level.

At the 12" point, measure down. This
is your roof pitch.



SELECT ROOF SHAPE

-  Flat Roof
-  Gable
-  Hip Pyramid
-  Hip End & Ridge
-  Cone Turret
-  5-Facet Hip
-  6-Facet Hip
-  7-Facet Hip
-  Hexagon Turret
-  Octagon Turret

Company:	Item: FINIAL FL005
Invoice:	Material:
PO#:	Notes:
Architect:	
Contractor:	
Date:	
Approved by:	
Signature:	

CUSTOM ORDERS CAN NOT BE RETURNED