

RUTLAND GUTTER SUPPLY LLC

sales@rutlandguttersupply.com Ph: 407-859-1119 Fax: 407-859-1123

FL032

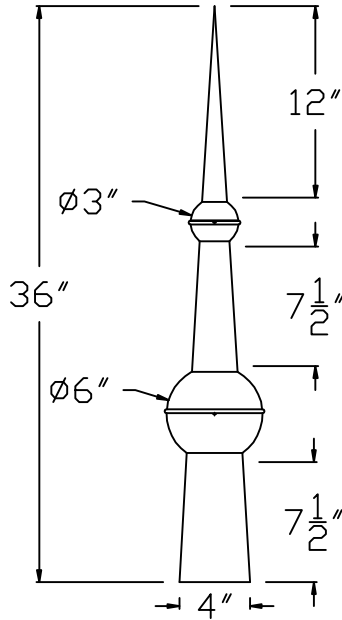

FRONT VIEW

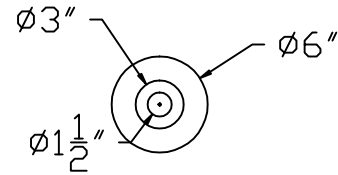

TOP VIEW

SPECIFY ROOF PITCH

To determine roof pitch:
Use a straight edge atleast 12" long,
Put corner on roof, holding vertically
level.

At the 12" point, measure down. This
is your roof pitch.

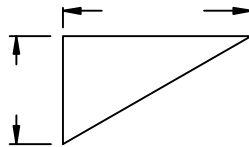
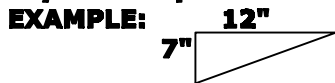

SELECT ROOF SHAPE

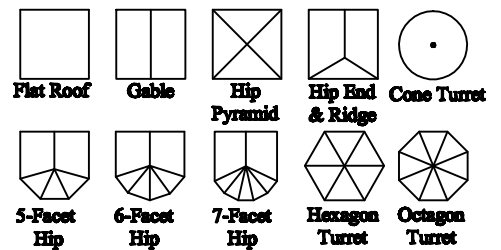

Company:	Item: FL032
Invoice:	Material:
PO#:	Notes:
Architect:	
Contractor:	
Date:	
Approved by:	
Signature:	

CUSTOM ORDERS CAN NOT BE RETURNED