

# RUTLAND GUTTER SUPPLY LLC

rutlandguttersupply@yahoo.com Ph: 407-859-1119 Fax: 407-859-1123

## LH004

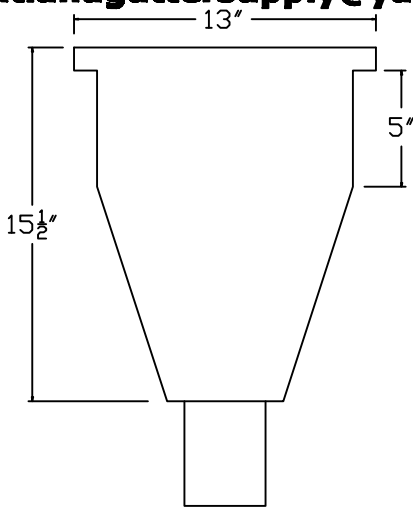

BACK VIEW

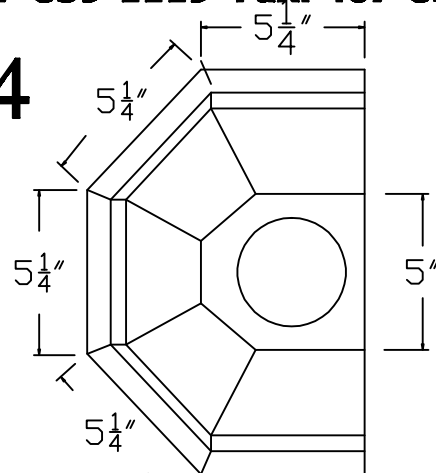

TOP VIEW

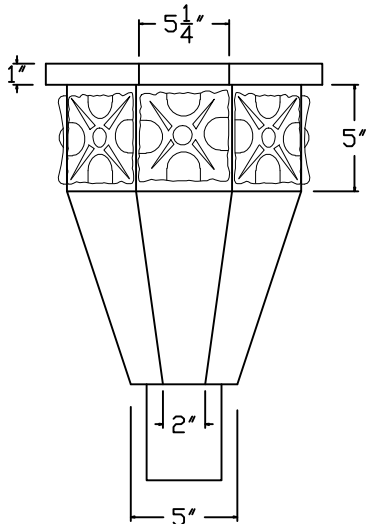

FRONT VIEW

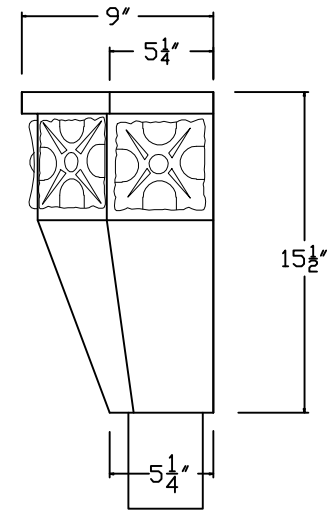

SIDE VIEW

**RUTLAND RESERVES THE RIGHT TO CHANGE OR MODIFY. DIMENSIONS SHOWN ARE FOR REFERENCE ONLY**

<b>Company:</b>	<b>Item:</b>
<b>Invoice:</b>	<b>Material:</b>
<b>PO#:</b>	<b>Notes:</b>
<b>Architect:</b>	
<b>Contractor:</b>	
<b>Date:</b>	
<b>Approved by:</b>	
<b>Signature:</b>	

**CUSTOM ORDERS CAN NOT BE RETURNED**